

The cycle of color

Making sure things don't get too colorful when using plastic recyclates

For years, the mass of recyclable plastic waste has been steadily increasing. This is due, on the one hand, to technical progress in the processing and sorting of plastic waste and, on the other hand, to the EU's recycling targets to increase the statutory recycling rate of plastic packaging to 50% by 2025 and to 55% by 2030. In addition, the requirements for the recyclates obtained by means of the recycling process are also increasing. In addition to the type of plastic and its former purpose, the color of the recyclate is also playing an increasingly important role.

Recycling and recovery of raw materials are now the defining issues within the plastics industry. By 2025, the recycling rate for plastic packaging is to increase to 50% initially and then to 55% by 2030, according to EU targets. For recycling companies, the technical effort required to achieve and maintain these quotas is growing disproportionately. In addition, however, consumer expectations of high-quality and visually flawless recycled plastic packaging are also rising. Particularly when it comes to the visual appearance of the packaging, consumers value continuity and homogeneity. Small differences in color or brightness from package to package can be detected quite well by the respective viewer. In the vast majority of cases, consumers draw conclusions about the contents of the packaging based on the quality of the packaging: if the packaging is not right, the product is not right either.

In terms of process technology, it is relatively easy to keep the color value of a package constant when virgin plastic granules are used, since the process of color homogeneity is quite well mastered by masterbatch producers. Technically sophisticated dosing systems mix masterbatch and base granules in the empirically determined optimum ratio. The minimal color deviations from packaging to packaging are thus no longer visible to the naked eye. The term dE (distance between two color values in the $L^*a^*b^*$ color space) used in professional circles is below 1.

With the help of color sorting during the separation of the recycling stream, an attempt is now made to keep the color of the plastic recyclate constant. To ensure that the tolerance limits for the color value are not exceeded, however, constant product monitoring is required with regard to the color. The SPECTRO-3-0°/45°-MSM-LAB-ANA-P laboratory instrument from Sensor Instruments GmbH, described below, is designed to help monitor and document the color progression of the recyclates.

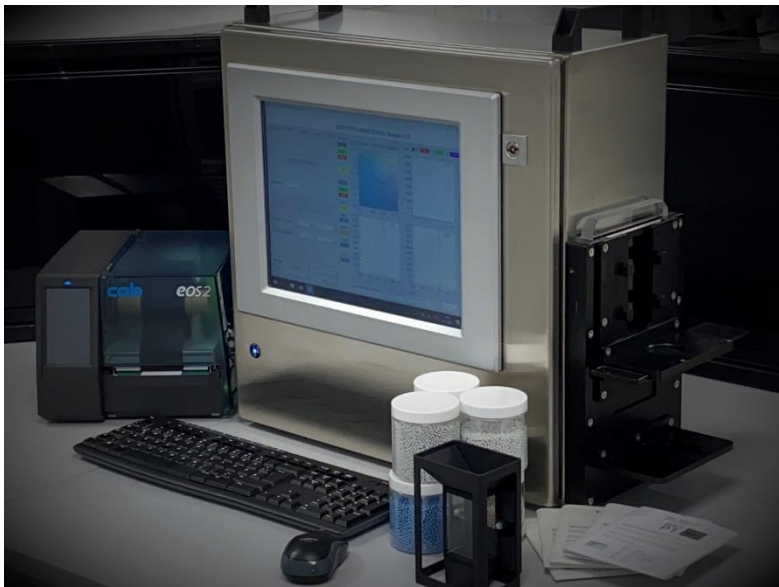

The idea is to take samples from the recyclate stream at regular intervals and then feed them to the laboratory color measurement system. In addition to the color value $L^*a^*b^*$, the device also displays its deviation $dL^*da^*db^*$ from a reference color value. Furthermore, each sample is documented and can subsequently be provided with a label indicating the respective date, time and $L^*a^*b^*$ and $dL^*da^*db^*$ value.

The measuring principle

The so-called 0°/45° method is used as the basis for color measurement, whereby the recyclate sample is illuminated under 0° and observed under 45°. The recyclate is placed behind a glass plate during the measurement, so the distance from the sensor head to the recyclate is constant.

A recyclate surface with a diameter of approx. 20mm is illuminated and observed, thus a sufficiently high optical averaging is achieved, whereby the slightly differing position of the pellets from measurement to measurement no longer has any noticeable influence on the measurement result. Two components essentially make up the measuring system; the first is the actual evaluation unit, with integrated microprocessor, electronics including optoelectronics, and electrical and optomechanical interface. The second is the optical frontend, which is connected to the evaluation unit via two optical fiber strands. The color measurement system has an RS232 interface, the color evaluation unit is connected to a panel PC integrated in the system via an RS232/USB

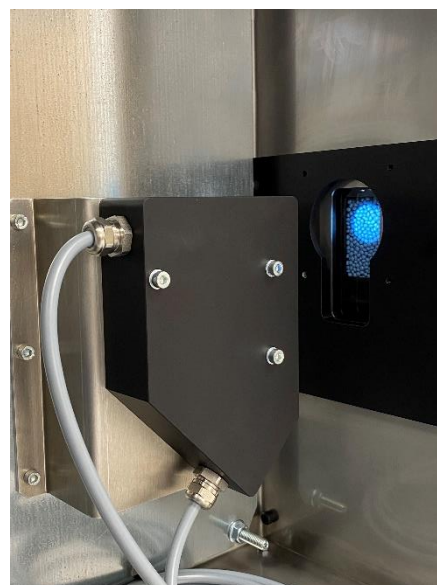
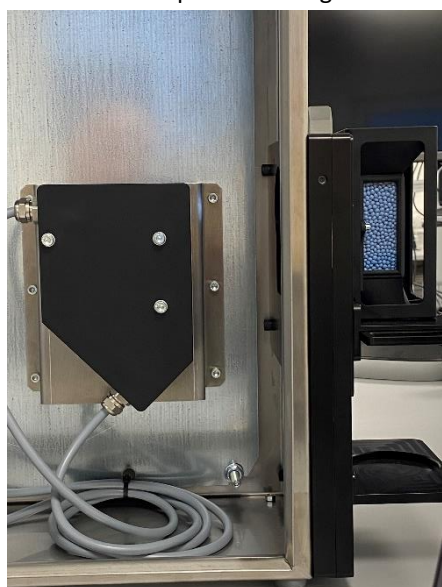

converter. By means of a hopper unit, the plastic recyclate is placed as tightly packed as possible in front of the 15mm thick glass pane separating the interior from the exterior. After the measurement has been completed, the plastic recyclate is filled back into the empty sample container by pulling the mechanical slide. RAL plastic cards are used to calibrate the measuring system. Care should be taken to ensure that the colors of the plastic cards used correspond approximately to those of the pellet samples. For this purpose, the pellet hopper is removed from the measuring system and the calibration cards (RAL plastic cards) can then be inserted one after the other into the opening provided for this purpose. Using SPECTRO3 MSM DOCAL Scope V1.0 software, the operator of the measuring system is guided through the calibration process.

The measuring system

Essentially, the color measurement system consists of the following components:

- ▶ Evaluation unit (panel PC, sensors, calibration card holder, recess for the pellet sample container with sight glass, slider, +24V power supply, USB interface, ON/OFF switch, Ethernet interface)
- ▶ Label printer
- ▶ Pellet sample container
- ▶ RAL plastic cards
- ▶ Keyboard and mouse



Laboratory color measurement system
SPECTRO-3-0°/45°-MSM-ANA-P

The calibration card holder unit without pellet hopper

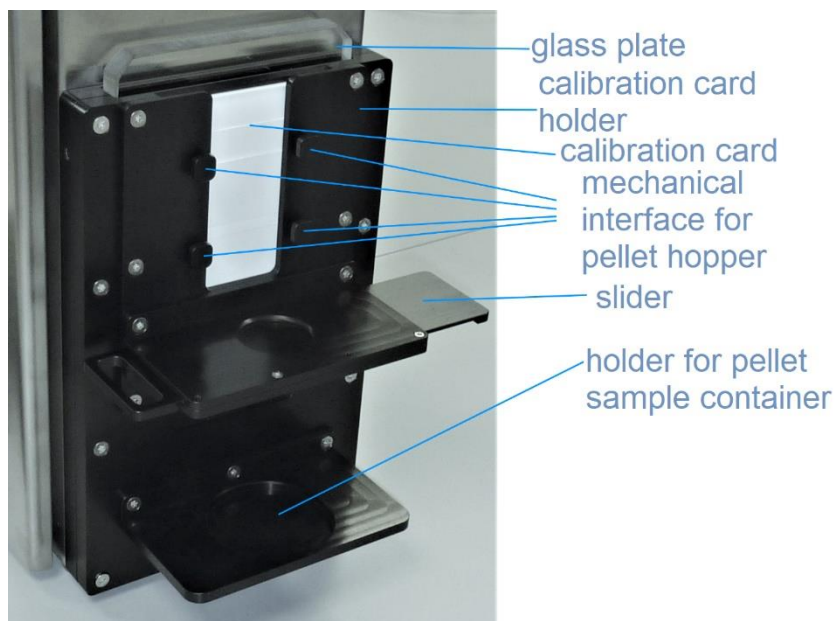

The calibration card holder unit attached to the side of the stainless steel housing enables calibration of the color sensor to the respective calibration card (RAL plastic card). The glass plate is located directly in front of the calibration card and between the calibration card and the color sensor. The RAL plastic cards are measured according to the d/8° method as standard and are provided with a corresponding imprint on the card cover.

In addition, Sensor Instruments calibration cards are measured using the 45°/0° method. Corresponding labels are attached to both the calibration cards and the

corresponding sleeves. After calibrating the sensor system to the RAL plastic cards in question, the pellet hopper unit can be flanged to the calibration card holder unit.

The calibration card holder unit with pellet hopper

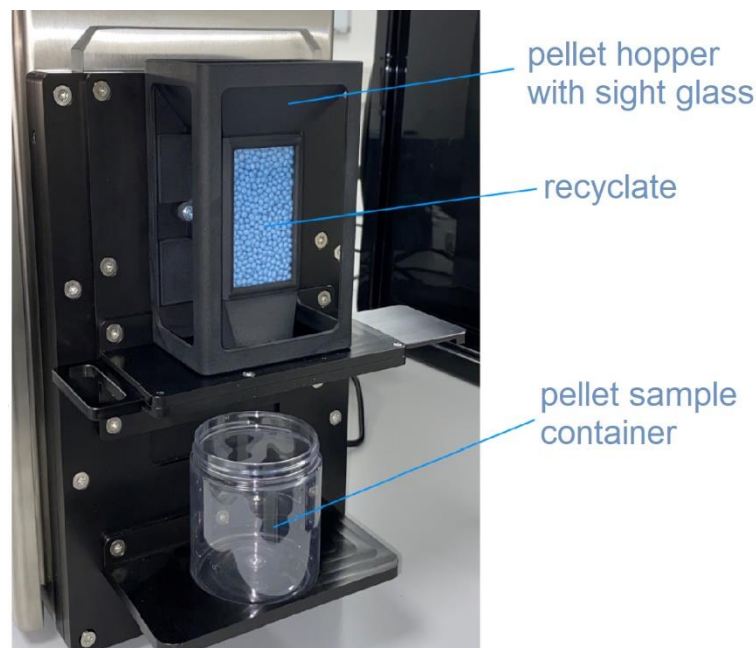

After the pellet hopper unit has been flanged to the calibration card receiver unit, the plastic recyclate can be fed via the hopper. The recyclate can be viewed through the sight glasses integrated in the pellet hopper unit. In addition, the plastic pellets fill the interior space between the glass plate and the funnel unit almost completely. The pellets are therefore packed as tightly as possible against the glass surface facing the pellet hopper unit.

The calibration cards

RAL plastic cards are used as calibration cards. Since these were measured at the factory (RAL gemeinnützige GmbH, Bonn) according to the d/8° method (diffusely illuminated and viewed below 8° to the normal), whereas the color sensor system used in the laboratory color measurement system is based on the 0°/45° measurement method, the available RAL cards from Sensor Instruments were re-measured according to the 45°/0° method by means of a calibrated hand-held device; the corresponding L*a*b* values were attached by means of labels to the respective cards as well as card covers. In addition, a file was created,



thereby an assignment of the RAL numbers was made with regards to the matching L*a*b* color values.

Pellet sample container and recyclates

For the respective recyclates to be tested, pellet sample containers are available which have been selected in terms of their dimensions so that they both fit into the recess provided in the calibration card holder unit and, in addition, the amount of recyclate matches the volume of the pellet hopper unit. For calibration of the color measurement system it is recommended to use RAL plastic cards, which visually resemble the respective recyclate samples in color.



Calibration of the evaluation unit

Before measurement can begin, the color evaluation unit must first be calibrated. Calibration is performed with the aid of RAL plastic cards. In addition to the calibration to a white plastic card, the so-called white balance, for example with the help of the RAL plastic

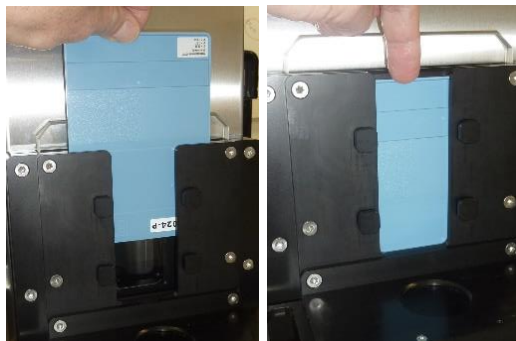

card RAL9003-P, RAL plastic cards should be used for calibration, if possible, which visually resemble the recyclates to be examined in terms of color. By means of the Windows® DOCAL software, the user is guided through the calibration process and requested to enter the names of the respective RAL plastic cards into the software fields provided for this purpose on the screen and furthermore to insert the respective calibration card into the opening provided for this purpose in the calibration card holder unit. This procedure must be repeated for all the RAL plastic cards provided. It is not necessary to repeat the calibration procedure

before each measurement, but it is advisable to perform a calibration procedure extended by these calibration cards after adding further recyclate samples whose colors are not yet covered by the calibration cards in use.

Color measurement of recyclate samples

After successful calibration, the pellet funnel unit must still be flanged onto the calibration card holder unit for color measurement of plastic recyclates. First, the RAL plastic card that may still be present in the calibration card holder unit must be removed. After opening the pellet sample container, pour the pellets completely into the pellet hopper unit and place the empty sample container below it in the recess provided for this purpose.

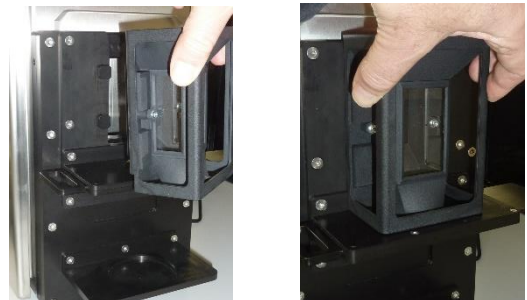

In the following pastel blue recyclate samples are to be measured in terms of color. These samples are similar to the RAL plastic card RAL5024-P, which was also used for calibration of the laboratory color measurement system. The calibration card does not necessarily have to match the recyclate sample exactly in color, but the accuracy of the measuring system is increased if RAL plastic cards are

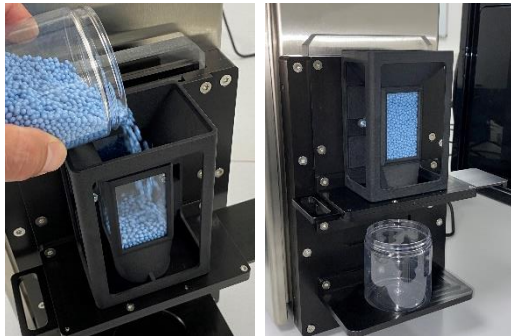
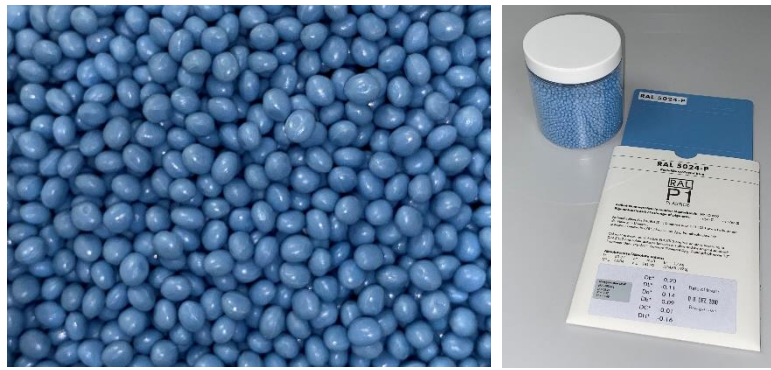

used for calibration which are at least close in color to the recycled samples. In the next step, the pellets are completely filled from the sample container into the pellet hopper unit. After the plastic recyclate is now in position, the actual measuring process can be started. For this purpose, the menu item TEACH is called up in the Windows® software SPECTRO3 MSM DOCAL Scope V1.0. The $L^*a^*b^*$ color values of the plastic pellet sample can now be stored in the TEACH table (after clicking the "TEACH DATA TO" software button).

In the case of the pastel blue recyclate sample, the color value is $L^* = 61.69$, $a^* = -7.22$, $b^* = -20.24$.

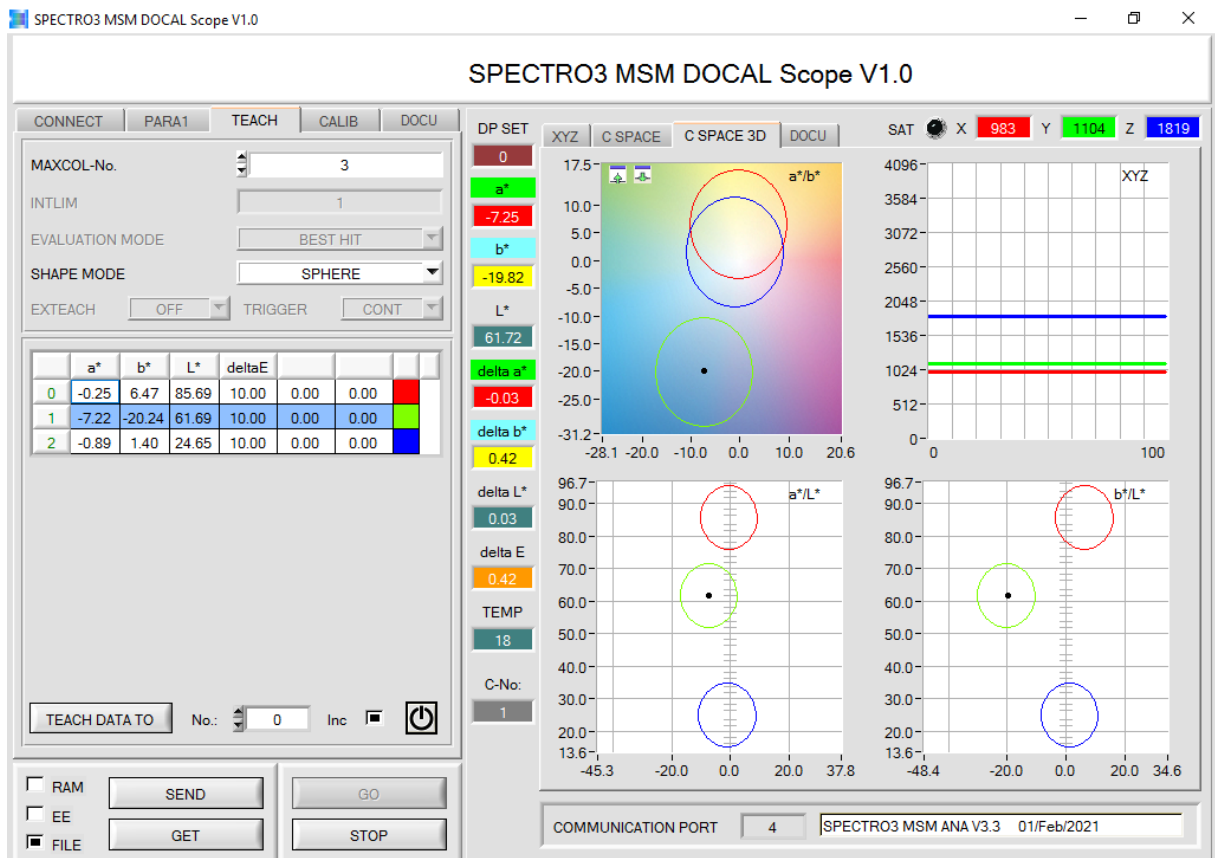

Windows® surface SPECTRO3 MSM DOCAL Scope V1.0, menu item TEACH

In addition to the current $L^*a^*b^*$ color values, the software now also displays the dL^* , da^* and db^* color deviations from the taught-in reference. Additionally, the total color deviation in the color space dE is displayed numerically. The graphs show the position of the current color value and the taught-in references (from the TEACH table) from three different angles (a^*b^* , a^*L^* and b^*L^*). Switching to the DOCU menu item brings us to the Windows® interface, where the individual measurements can be seen and furthermore the labels as well as the files for storing the color values can be created.

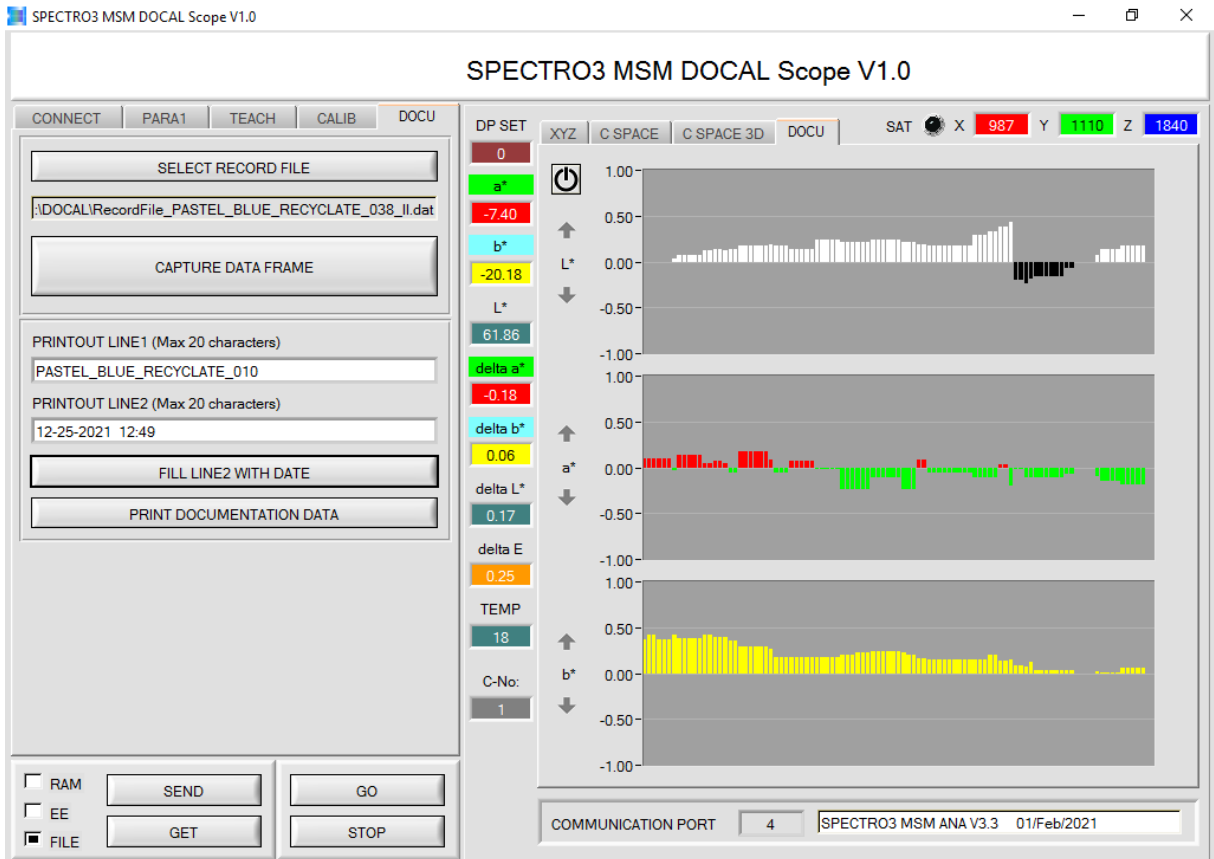

Windows® surface SPECTRO3 MSM DOCAL Scope V1.0, menu item DOCU

In the right section of the Windows® interface, the last 100 measurements are displayed, rather the deviations in L^* , a^* and b^* to the entered reference in the TEACH table, thus the dL^* , da^* and db^* values. In the left section of



the Windows® interface, a file can be defined in which the measurement data are to be stored. Furthermore, the label inscription can be specified. This is done by line 1 and optionally line 2. However, line 2 can also be used to output the current date and time.

The label will be created by clicking the „PRINT DOCUMENTATION DATA“ button.

After completion of the measurement series, the created file „RecordFile_PASTEL_BLUE_RECYCLATE_038_II.dat“ can be opened, for example, with Microsoft Excel:

DATE	TIME	X	Y	Z	L^*	a^*	b^*	delta E	delta L^*	delta a^*	delta b^*	COLOR	TEMP
12-25-2021	12:39:10	983	1103	1819	61.688	-7.122	-19.870	0.382	0.000	0.097	0.369	1	18
12-25-2021	12:39:16	983	1103	1817	61.688	-7.122	-19.820	0.429	0.000	0.097	0.418	1	18
12-25-2021	12:39:18	983	1103	1817	61.688	-7.122	-19.820	0.429	0.000	0.097	0.418	1	18
12-25-2021	12:39:20	983	1103	1819	61.688	-7.122	-19.870	0.382	0.000	0.097	0.369	1	18
12-25-2021	12:39:21	983	1103	1819	61.688	-7.122	-19.870	0.382	0.000	0.097	0.369	1	18
12-25-2021	12:39:22	983	1103	1819	61.688	-7.122	-19.870	0.382	0.000	0.097	0.369	1	18
12-25-2021	12:39:23	983	1104	1819	61.717	-7.249	-19.819	0.422	0.029	-0.030	0.420	1	18
12-25-2021	12:39:44	986	1106	1823	61.761	-7.084	-19.854	0.414	0.073	0.134	0.385	1	18
12-25-2021	12:39:45	986	1106	1823	61.761	-7.084	-19.854	0.414	0.073	0.134	0.385	1	18
12-25-2021	12:39:46	986	1106	1823	61.761	-7.084	-19.854	0.414	0.073	0.134	0.385	1	18
12-25-2021	12:39:46	986	1106	1823	61.761	-7.084	-19.854	0.414	0.073	0.134	0.385	1	18
12-25-2021	12:39:47	986	1106	1823	61.761	-7.084	-19.854	0.414	0.073	0.134	0.385	1	18
12-25-2021	12:39:52	987	1108	1824	61.805	-7.178	-19.815	0.442	0.117	0.041	0.424	1	18
12-25-2021	12:39:53	987	1108	1824	61.805	-7.178	-19.815	0.442	0.117	0.041	0.424	1	18
12-25-2021	12:39:54	988	1109	1827	61.827	-7.144	-19.851	0.419	0.140	0.075	0.388	1	18
12-25-2021	12:39:55	988	1109	1827	61.827	-7.144	-19.851	0.419	0.140	0.075	0.388	1	18
12-25-2021	12:39:56	987	1108	1825	61.805	-7.178	-19.839	0.418	0.117	0.041	0.399	1	18
12-25-2021	12:39:59	987	1109	1828	61.827	-7.273	-19.887	0.382	0.140	-0.054	0.351	1	18
12-25-2021	12:40:00	987	1109	1828	61.827	-7.273	-19.887	0.382	0.140	-0.054	0.351	1	18
12-25-2021	12:40:00	990	1110	1832	61.857	-7.045	-19.948	0.379	0.169	0.173	0.291	1	18
12-25-2021	12:40:01	990	1110	1832	61.857	-7.045	-19.948	0.379	0.169	0.173	0.291	1	18
12-25-2021	12:40:02	990	1110	1832	61.857	-7.045	-19.948	0.379	0.169	0.173	0.291	1	18
12-25-2021	12:40:03	989	1110	1832	61.857	-7.045	-19.948	0.379	0.169	0.173	0.291	1	18
12-25-2021	12:40:04	989	1110	1832	61.857	-7.045	-19.948	0.379	0.169	0.173	0.291	1	18